

PLAN VIEW

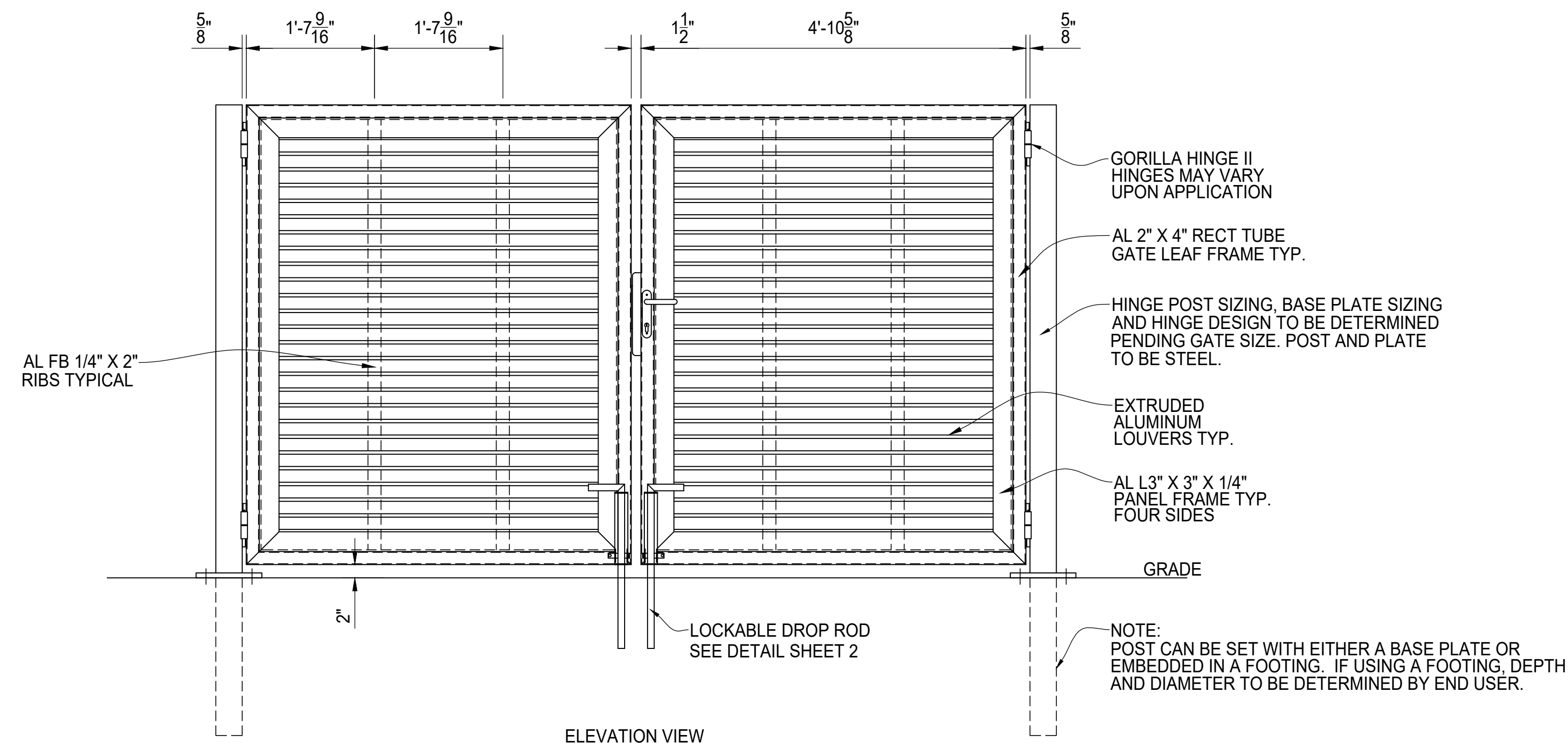

ELEVATION VIEW

DOUBLE DRIVE GATE ASSEMBLY  
SEE DETAIL SHEET 2 FOR HINGE, LATCH AND DROP ROD

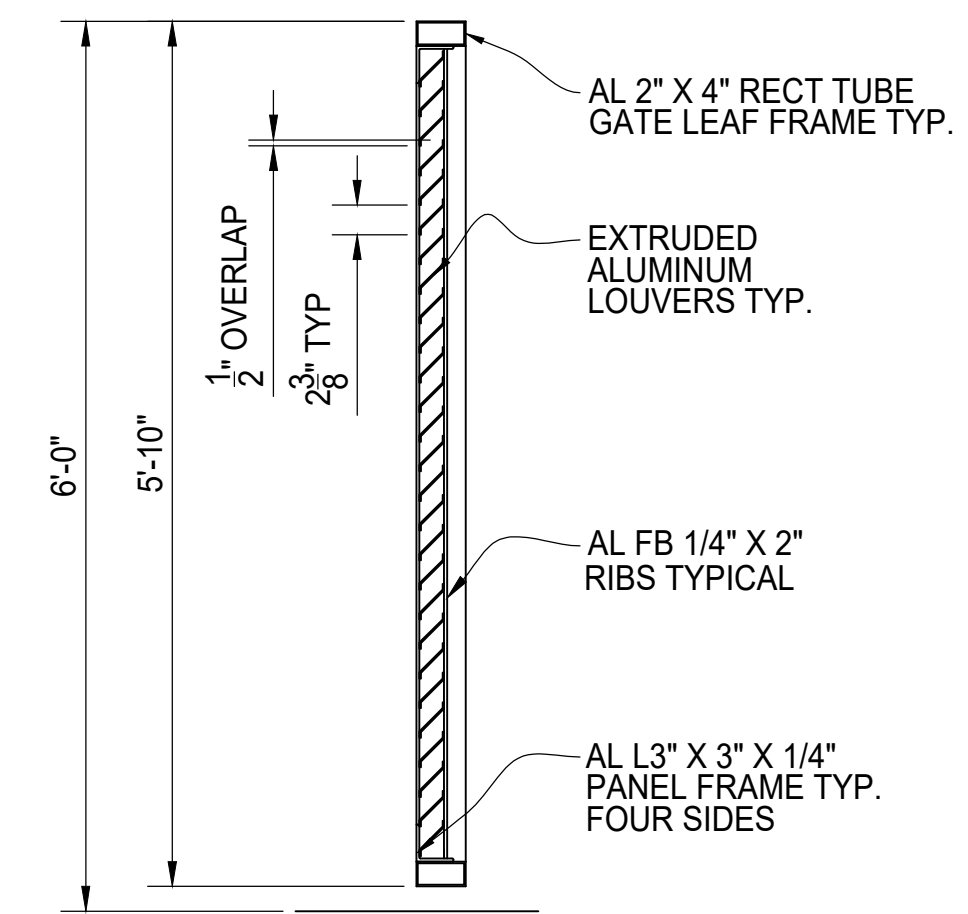

SIDE VIEW

GATE SECTION



MAXIMUS 6' TALL  
HORIZONTAL LOUVER INFILL  
10' WIDE DOUBLE DRIVE  
GATE ELEVATION